

Limit Switches - Prewired Type Plastic Body

CARLO GAVAZZI



- Double Insulation □ (for thermoplastic type)
- Sealed with epoxy resin at the base of the box
- Degree of protection IP67
- Thermoplastic material body
- Positive Opening Operation →
- Minimum Actuation Force/Torque
- Minimum Force to achieve Positive Opening Operation
- Precise operating points (consistency)
- Immune to electromagnetic disturbances
- Zb type contact blocks
- Current I_{th} = 10A
- Rated insulation voltage U_i = 500V
- UL, CSA, CE, RoHS
- Conform with IEC 947-5-1 (EN 60947-5-1)

Product Description

They are developed with very compact size, to enable its mounting on machine's moving member during adverse environmental conditions and controlling their position.

Ordering Key

PS31M-CS11RT-T00

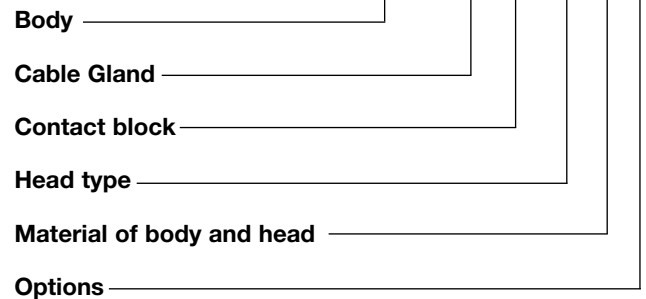

Description of the key codes

Body

PS31M | PS 40mm (fix 20mm) 1m cable lateral side (prewired)

Cable Gland

C | Prewired - std cable
U | Prewired - UL cable

Contact block

S11 | 1NO+1NC snap(+)
T11 | 1NO+1NC slow(+)

Material of body and head

T | Thermoplastic Body and Metal head

Options

00 | no option
0L | with fixing nuts (only with head type P0, PR, PY, P9, P8)

Head type

BE | nylon roller ext bent LEVER
BO | ball roller bent LEVER
BR | nylon roller int bent LEVER
L3 | adj square (3x3) steel rod LEVER
LA | adj Ø3 rod LEVER stainless steel rod
LB | nylon actuator with stainless steel spring
LF | adj fiberglass rod LEVER Ø3
LG | adj fiberglass rod LEVER Ø6
LN | adj nylon rod LEVER
LP | multidir nylon actuator with stainless steel spring
LS | stainless steel spring multidir actuator
LW | Stainless steel spring multidir actuator (cat Whisker)
LZ | Stainless steel spring actuator
P0 | metal plain PLUNGER
P8 | nylon cross roller PLUNGER with fixing nuts
P9 | cross metal roller PLUNGER
PH | metal PLUNGER +gasket
PR | metal roller PLUNGER
PY | nylon roller PLUNGER
R1 | adj LEVER with nylon roller
R2 | adj LEVER with stainless steel roller
RM | metal roller LEVER
RO | roller LEVER steel ball bearing
RS | metal roller LEVER
RT | nylon roller LEVER
W1 | adj LEVER with Ø50 rubber roller

Technical Data

Standards

Certifications – Approvals

Air temperature near the device

- during operation
- for storage

°C
°C

Devices conform with international IEC 947-5-1 and European EN 60947-5-1 standards

UL, CSA, CE, RoHS

-25 ... +70

-40 ... +70

Mounting positions

All positions are authorized

Protection against electrical shocks (acc.to IEC 536)

Degree of protection (according to IEC 529 and EN 60 529)

Degree of protection (according to UL50)

Class II

IP67

Type 1 enclosure ("indoor use only")

Electrical Data

Rated insulation voltage U_i

-according to IEC 947-1 and EN 60-947-1

-according to UL 508, CSA C22-2 n°14

400V (degree of pollution 3)

B 300, R 300

Rated impulse withstand voltage U_{imp}

kV

(according to IEC 60947-1 and EN 60947-1)

4

Conventional enclosed thermal current I_{th}

A

(according to IEC 60947-1 and EN 60947-5-1) ($\theta \leq 40^\circ\text{C}$)

5

Short-circuit protection - gG type fuses

A

6

Rated operational current

I_e / **AC-15** - acc.to IEC 60947-5-1

24Vac (50/60 Hz) A

120Vac (50/60 Hz) A

240Vac (50/60 Hz) A

5.0

3.0

1.5

I_e / **DC-13** - acc.to IEC 60947-5-1

24Vdc A

110Vdc A

250Vdc A

1.1

0.22

0.1

Electrical durability (according to IEC 60497-5-1 annex C)

- max. switching frequency Cycles/h
- load factor

Utilization categories AC-15 and DC-13 (see curves and value below)

3600

0.5

Mechanical durability

10 millions of operations

Diagram for snap action contact

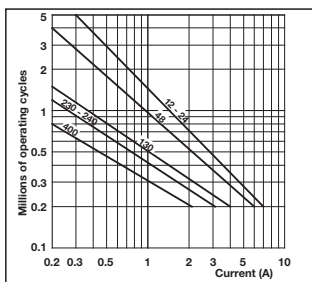
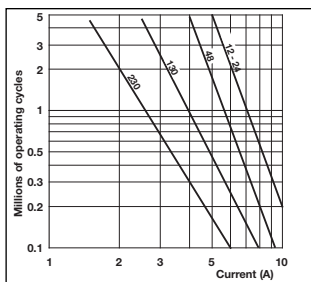

Diagram for slow action contact



Electrical durability for DC-13 utilization category

Power breaking for a durability of 5 million operating cycles		
	Snap action	Slow action
Voltage 24V	9,5W	12W
Voltage 48V	6,8W	9W
Voltage 110V	3,6W	6W

Limit Switches - Miniature Type (PS31M) Plastic Body IP67



▣ Cable Characteristics

C = Pre-wired, 1m standard cable 4x0.75mm²
U = Pre-wired, 1m UL cable 4x0.75mm²

(Different lengths available on request)

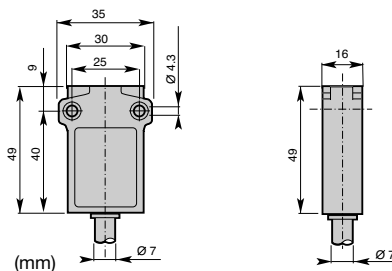

▲ Contact block (Zb type)

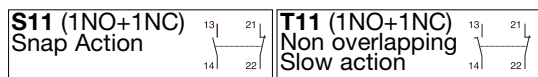

		<p>S11</p>	<p>T11</p>
		<p>S11</p>	<p>T11</p>
		<p>S11</p>	<p>T11</p>
		<p>S11</p>	<p>T11</p>

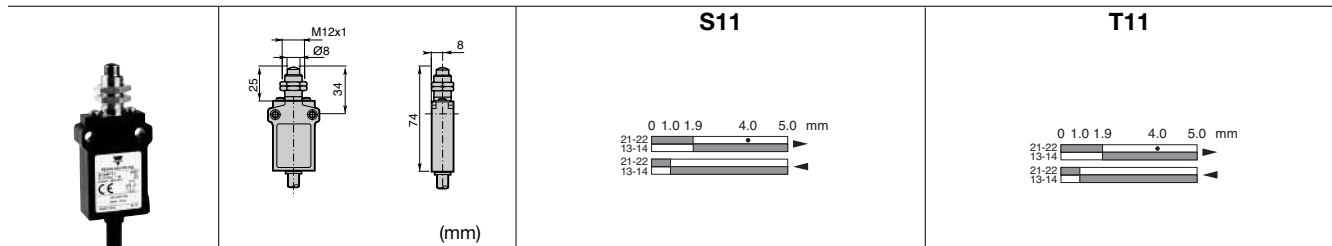

Conformity / (NC) /
 Max. Actuation speed 0.5ms
 Min. force or torque 15N / 30Nm
 Weight 140g

S11
 Pain plunger with fixing nuts
 Code

T11
 PS31M- P0-T0L

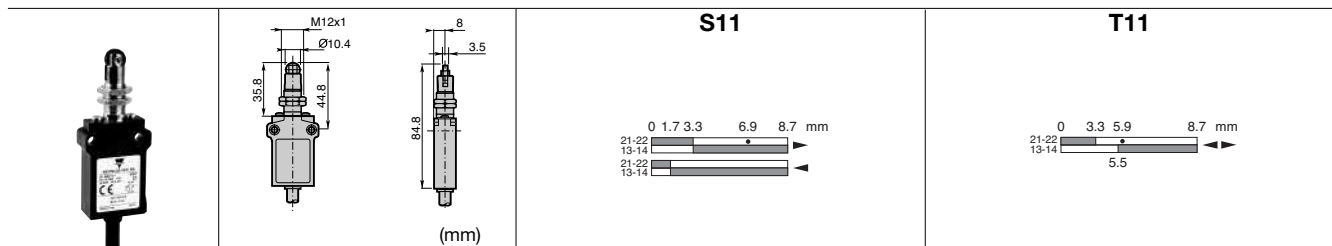

Conformity / (NC) /
 Max. Actuation speed 0.1ms
 Min. force or torque 10N / 30Nm
 Weight 145g

S11
 Roller plunger with fixing nuts
 Code metal roller
 nylon roller

T11
 PS31M- PR-T0L
 PS31M- PY-T0L

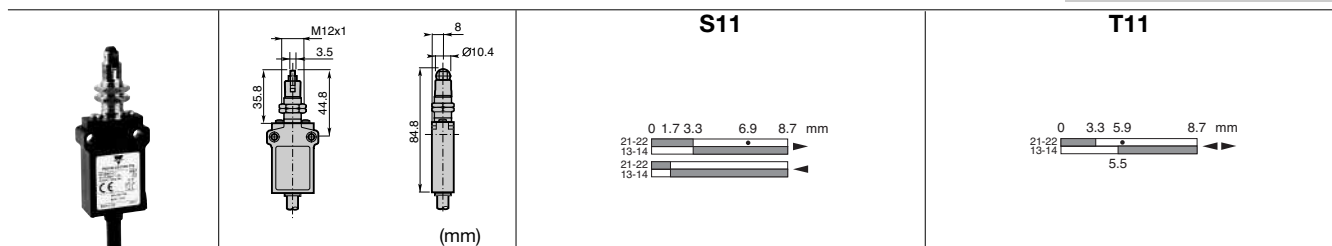

Conformity / /
 Max. Actuation speed 0.1ms
 Min. force or torque 10N / 30Nm
 Weight 145g

S11
 Cross roller plunger with fixing nuts
 Code metal roller
 nylon roller

T11
 PS31M- P9-T0L
 PS31M- P8-T0L

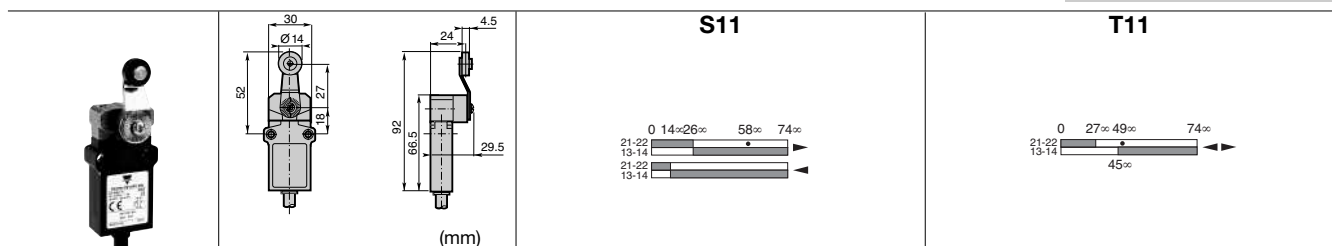

Conformity / (NC) /
 Max. Actuation speed 1.5ms
 Min. force or torque 0.08N / 0.28Nm
 Weight 175g

S11
 Ø14 roller lever
 Code nylon roller
 metal roller
 ball bearing

T11
 PS31M- RT-T00
 PS31M- RS-T00
 PS31M- RO-T00

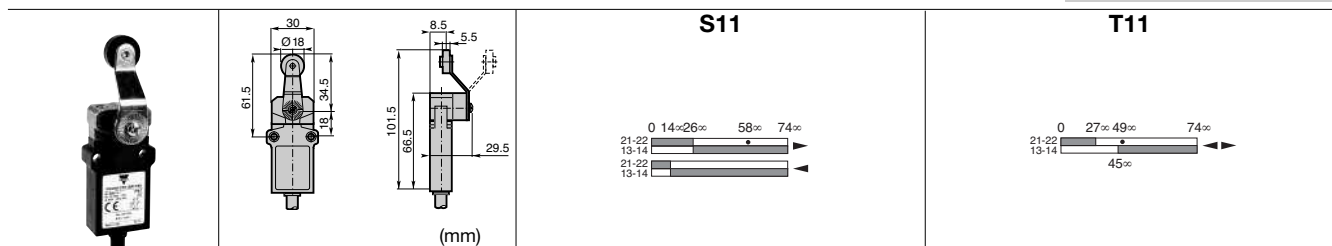

Conformity / (NC) /
 Max. Actuation speed 1.5ms
 Min. force or torque 0.08N / 0.28Nm
 Weight 180g

S11
 Ø18 nylon roller lever
 Code

T11
 PS31M- BR-T00

Limit Switches - Miniature Type (PS31M) Plastic Body IP67



▣ Cable Characteristics

C = Pre-wired, 1m standard cable 4x0.75mm²
U = Pre-wired, 1m UL cable 4x0.75mm²

(Different lengths available on request)

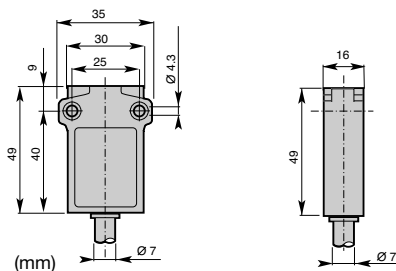

▲ Contact block (Zb type)

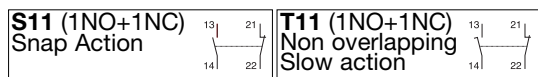

		S11	T11

Conformity / (NC) / (NC)
Max. Actuation speed 1.5ms
Min. force or torque 0.08N / 0.28Nm
Weight 190g

Adjustable lever with Ø18 nylon roller
Code PS31M-**•▲R1-T00**

		S11	T11

Conformity / (NC) / (NC)
Max. Actuation speed 1.5ms
Min. force or torque 0.08N / -
Weight 190g

Nylon actuator with stainless steel spring
Code PS31M-**•▲LB-T00**

		S11	T11

Conformity / (NC) / (NC)
Max. Actuation speed 1.5ms
Min. force or torque 0.08N / 0.28Nm
Weight 185g

Adjustable rod lever
Code stainless steel rod Ø3
 fiberglass rod Ø3
 square steel rod 3x3
PS31M-•▲LA-T00
PS31M-•▲LF-T00
PS31M-•▲L3-T00

		S11	T11

Conformity / (NC) / (NC)
Max. Actuation speed 1.5ms
Min. force or torque 0.08N / 0.28Nm
Weight 200g

Adjustable Ø6 rod lever
Code Nylon rod
 fiberglass rod
PS31M-•▲LN-T00
PS31M-•▲LG-T00

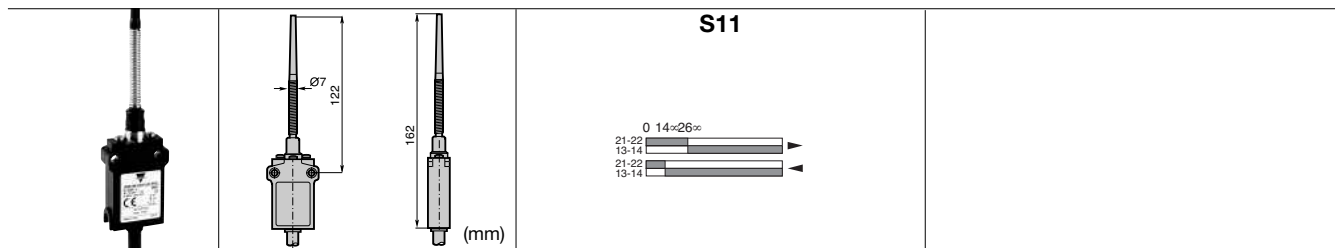

Conformity / (↻) (NC)	/ (↻)
Max. Actuation speed	1.0ms
Min. force or torque	0.10N / -
Weight	195g

Multidirectional nylon actuator with stainless steel spring
Code PS31M-▲LP-T00

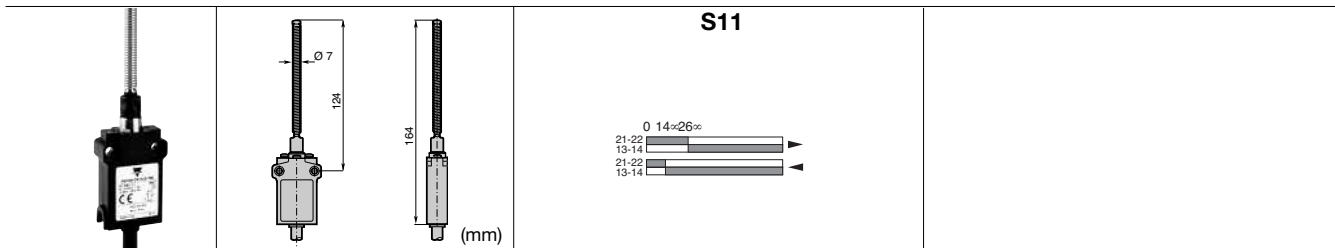

Conformity / (↻) (NC)	/ (↻)
Max. Actuation speed	1.0ms
Min. force or torque	0.10N / -
Weight	200g

Multidirectional actuator with stainless steel spring
Code PS31M-▲LS-T00

Adjustment and utilization precautions

Position adjustment of lever

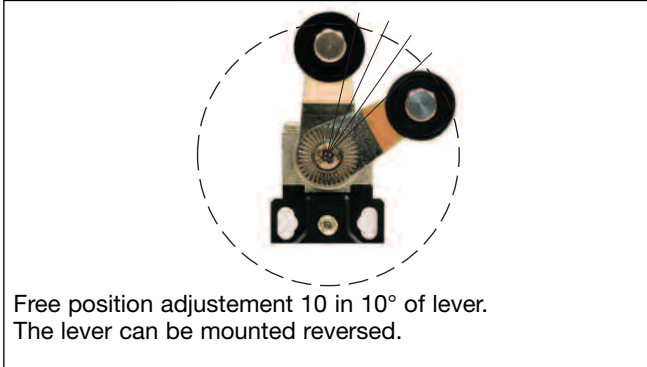

Plain plunger

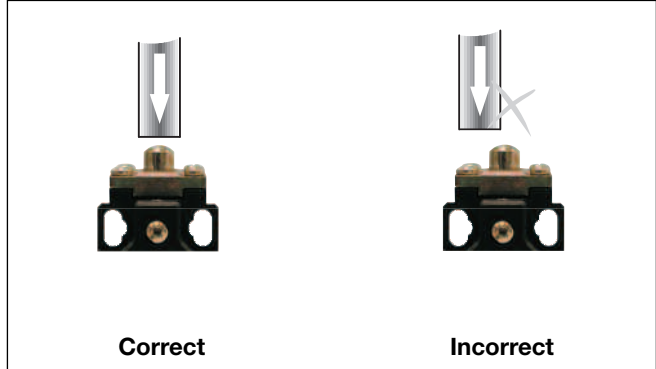

Roller plunger or Roller lever

